

### Compact Slim Twin and Single Type Automotive Relay

# CJ RELAYS

<Protective construction>  
Standard type: Sealed  
Pin in Paste compliant type: Flux tight

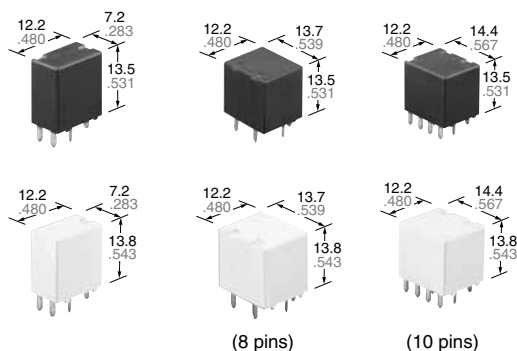

(Unit: mm inch)

**RoHS compliant**

## FEATURES

- It is extremely compact at approx. 2/3 the size of previous CT relay.
- Compact and high-capacity 25 A load switching
- Pin in Paste compliant model added

## TYPICAL APPLICATIONS

- Powered windows, Automatic door locks, Powered mirrors, Powered sunroofs, Powered seats, Lift gates, Smart J/B related products, etc.

## ORDERING INFORMATION

ACJ

Contact arrangement  
1: 1 Form C  
2: 1 Form Cx2 (8 pins)  
5: 1 Form Cx2 (10 pins)

Operate (Set) voltage  
1: Max. 6.5 V DC  
2: Max. 7.2 V DC

Rated coil voltage, DC  
12: 12 V

Mounting type  
Nil: Standard type  
P: Pin in Paste compliant type

## TYPES

Contact arrangement	Rated coil voltage	Operate (Set) voltage (at 20°C 68°F) (Initial)	Part No.		Packing	
			Standard type	Pin in Paste compliant type	Carton (tube)	Case
1 Form C	12 V DC	Max.6.5 V DC	ACJ1112	ACJ1112P	70 pcs.	2,800 pcs.
		Max.7.2 V DC	ACJ1212	ACJ1212P		
1 Form C × 2 (8 pins)		Max.6.5 V DC	ACJ2112	ACJ2112P	40 pcs.	1,000 pcs.
		Max.7.2 V DC	ACJ2212	ACJ2212P		
1 Form C × 2 (10 pins)		Max.6.5 V DC	ACJ5112	ACJ5112P	35 pcs.	1,400 pcs.
		Max.7.2 V DC	ACJ5212	ACJ5212P		

# RATING

## 1. Coil data

Rated coil voltage	Operate (Set) voltage (at 20°C 68°F) (Initial)	Release (Reset) voltage (at 20°C 68°F) (Initial)	Rated operating current [±10%] (at 20°C 68°F)	Coil resistance [±10%] (at 20°C 68°F)	Rated operating power (at 20°C 68°F)	Usable voltage range*
12 V DC	Max. 7.2 V DC	Min. 1.0 V DC	53.3 mA	225Ω	640 mW	10 to 16 V DC
	Max. 6.5 V DC	Min. 0.8 V DC	66.7 mA	180Ω	800 mW	9 to 16 V DC

Note: \*Other usable voltage range types are also available. Please inquire our sales representative for details.

## 2. Specifications

	Item	Specifications
Contact data	Contact arrangement	1 Form C, 1 Form C×2
	Contact resistance (initial)	Max. 50mΩ (N.O.: Typ. 7mΩ, N.C.: Typ. 10mΩ) (By voltage drop 1A 6V DC)
	Contact material	Ag alloy
	Rated switching capacity (resistive)	N.O. side: 20A 14V DC, N.C. side: 10A 14V DC
	Max. carrying current*1	N.O. side: 20 A for 1 hour, 30 A for 2 minutes (Coil applied voltage 14 V DC at 20°C 68°F)
	Min. switching load (resistive)*2	1A 14V DC (at 20°C 68°F)
Insulated resistance (initial)		Min. 100 MΩ (at 500V DC, Measurement at same location as "Dielectric strength" section.)
Dielectric strength (initial)	Between open contacts	500 Vrms for 1 min. (Detection current: 10mA)
	Between contacts and coil	500 Vrms for 1 min. (Detection current: 10mA)
Time characteristics (initial)	Operate (Set) time (at Rated voltage)	Max. 10ms (at 20°C 68°F, without bounce time)
	Release (Reset) time (at Rated voltage)	Max. 10ms (at 20°C 68°F, without bounce time) (without diode)
Shock resistance	Functional	Min. 100 m/s <sup>2</sup> {approx. 10G} (Half-wave pulse of sine wave: 11ms; detection time: 10μs)
	Destructive	Min. 1,000 m/s <sup>2</sup> {approx. 100G} (Half-wave pulse of sine wave: 6ms)
Vibration resistance	Functional	10 to 100 Hz, Min. 44.1m/s <sup>2</sup> {approx. 4.5G} (detection time: 10μs)
	Destructive	10 to 500 Hz, Min. 44.1m/s <sup>2</sup> {approx. 4.5G} Time of vibration for each direction; X, Y direction: 2 hours, Z direction: 4 hours
Expected life	Mechanical	Min. 10 <sup>7</sup> (at 120 cpm)
	Electrical	[Standard type] <Resistive load> Min. 10 <sup>5</sup> (at rated switching capacity, operating frequency: 1s ON, 9s OFF) <Motor load> N.O. side: Min. 2×10 <sup>5</sup> : at 25 A (inrush), 5 A (steady), 14 V DC; Min. 10 <sup>5</sup> : at 25 A 14 V DC (Motor lock) N.C. side: Min. 2×10 <sup>5</sup> : at 20 A 14 V DC (brake) (Operating frequency: 0.5s ON, 9.5s OFF) [Pin in Paste compliant type] <Resistive load> Min. 10 <sup>5</sup> (at rated switching capacity, operating frequency: 1s ON, 9s OFF) <Motor load> N.O. side: Min. 10 <sup>5</sup> : at 25 A (inrush), 5 A (steady), 14 V DC; Min. 5×10 <sup>4</sup> : at 25 A 14 V DC (Motor lock) N.C. side: Min. 10 <sup>5</sup> : at 20 A 14 V DC (brake) (Operating frequency: 0.5s ON, 9.5s OFF)
Conditions	Conditions for usage, transport and storage*3	Ambient temperature: -40 to +85°C -40 to +185°F Humidity: 5 to 85% R.H. (Please avoid icing or condensation)
Weight		1 Form C type: approx. 3.5 g .12 oz, Twin type: approx. 6.5 g .23 oz

Notes: \*1. Depends on connection conditions. Also, this does not guarantee repeated switching. We recommend that you confirm operation under actual conditions.

\*2. This value can change due to the switching frequency, environmental conditions, and desired reliability level, therefore it is recommended to check this with the actual load.

\*3. The upper operation ambient temperature limit is the maximum temperature that can satisfy the coil temperature rise value. For details, please refer to the "Automotive Relay Users Guide".

Please inquire our sales representative if you will be using the relay in a high temperature atmosphere (110°C 230°F).

\* If the relay is used continuously for long periods of time with coils on both sides in an energized condition, breakdown might occur due to abnormal heating depending on the carrying condition. Therefore, please inquire our sales representative when using with a circuit that causes an energized condition on both sides simultaneously.

## REFERENCE DATA

1.-(1) Coil temperature rise (at room temperature)

Sample: ACJ1212, 3pcs  
 Measured portion: Inside the coil  
 Carrying current: 10A, 15A, 20A  
 Ambient temperature: 25°C 77°F

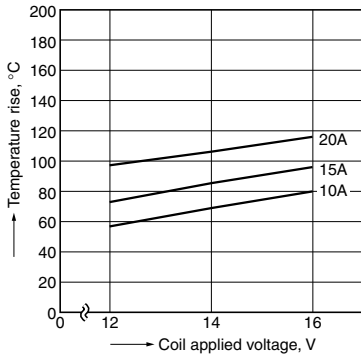

1.-(2) Coil temperature rise (at 85°C 185°F)

Sample: ACJ1212, 3pcs  
 Measured portion: Inside the coil  
 Carrying current: 10A, 15A, 20A  
 Ambient temperature: 85°C 185°F

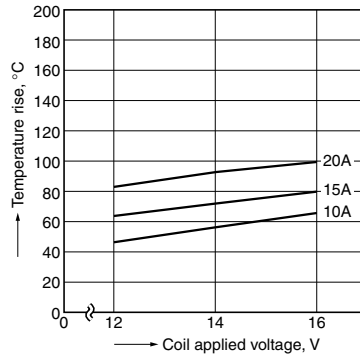

1.-(3) Coil temperature rise (at room temperature)

Sample: ACJ2212, 3pcs  
 Measured portion: Inside the coil  
 Carrying current: 10A, 15A, 20A  
 Ambient temperature: 25°C 77°F

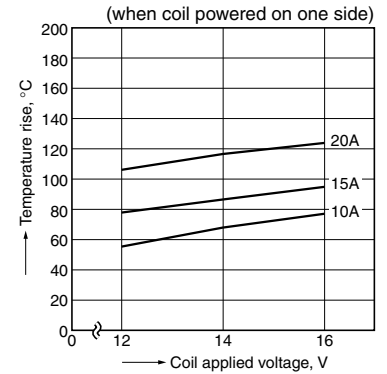

1.-(4) Coil temperature rise (at 85°C 185°F)

Sample: ACJ2212, 3pcs  
 Measured portion: Inside the coil  
 Carrying current: 10A, 15A, 20A  
 Ambient temperature: 85°C 185°F

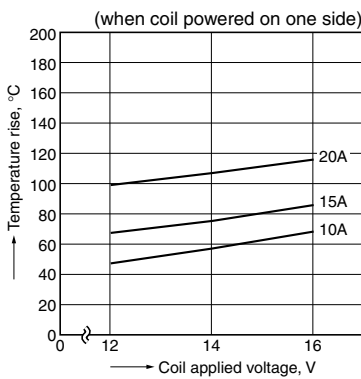

1.-(5) Coil temperature rise (at room temperature)

Sample: ACJ5212, 3pcs  
 Measured portion: Inside the coil  
 Carrying current: 10A, 15A, 20A  
 Ambient temperature: 25°C 77°F

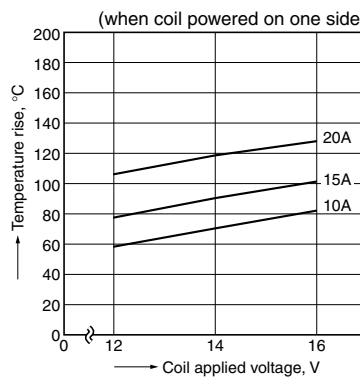

1.-(6) Coil temperature rise (at 85°C 185°F)

Sample: ACJ5212, 3pcs  
 Measured portion: Inside the coil  
 Carrying current: 10A, 15A, 20A  
 Ambient temperature: 85°C 185°F

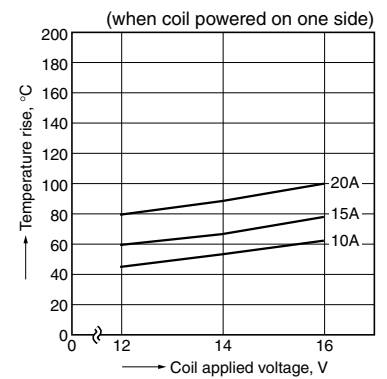

2.-(1) Ambient temperature and usable voltage range

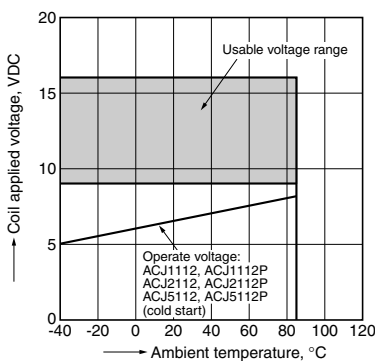

2.-(2) Ambient temperature and usable voltage range

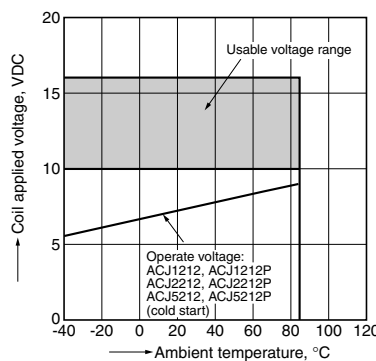

3.-(1) Distribution of operate (set) and release (reset) voltage

Sample: ACJ2112, 50pcs.  
 Ambient temperature: Room temperature

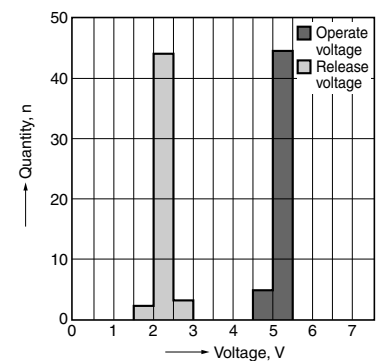

### 3.-(2) Distribution of operate (set) and release (reset) voltage

Sample: ACJ2212, 50pcs.  
Ambient temperature: Room temperature

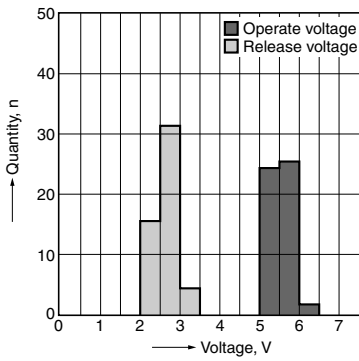

### 4.-(1) Distribution of operate (set) and release (reset) time

Sample: ACJ2112, 50pcs.  
Ambient temperature: Room temperature

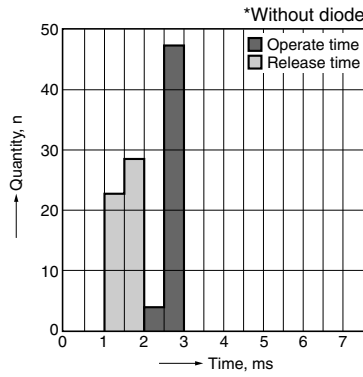

### 4.-(2) Distribution of operate (set) and release (reset) time

Sample: ACJ2212, 50pcs.  
Ambient temperature: Room temperature

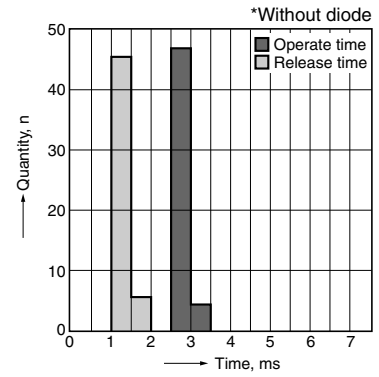

### 5.-(1) Electrical life test (Motor free)

Sample: ACJ2212, 3pcs  
Load: Inrush current: 25A, Steady current: 5A,  
Power window motor actual load (free condition)  
Tested voltage: 14V DC  
Switching frequency: ON 0.5s, OFF 9.5s  
Switching cycle:  $2 \times 10^5$   
Ambient temperature: Room temperature  
Circuit:

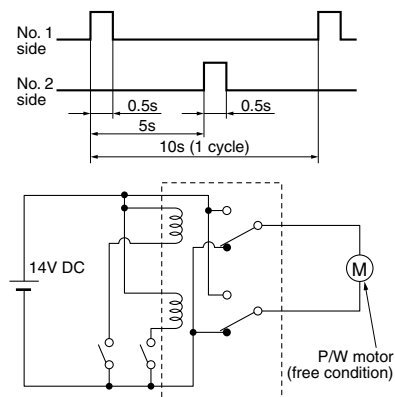

### Change of operate (set) and release (reset) voltage

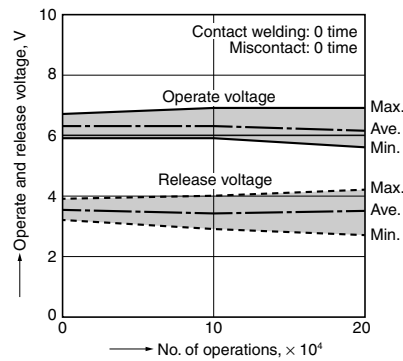

### Change of contact resistance

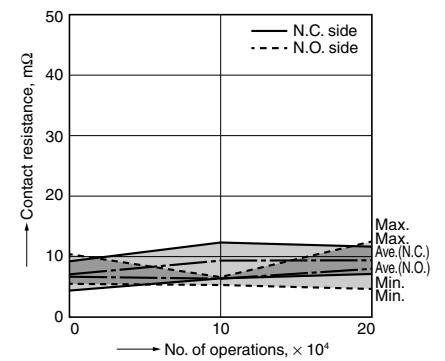

### Load current waveform

Load; Inrush current: 25A, Steady current: 6A,  
Brake current: 13A

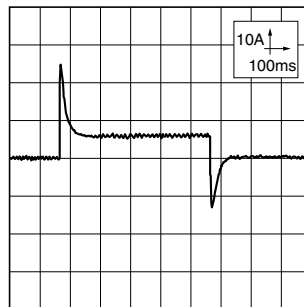

5.-(2) Electrical life test (Motor lock)

Sample: ACJ2212, 3pcs  
 Load: Steady current: 25A, Power window motor  
 actual load (lock condition)  
 Tested voltage: 14V DC  
 Switching frequency: ON 0.5s, OFF 9.5s  
 Switching cycle: 10<sup>5</sup>  
 Ambient temperature: Room temperature  
 Circuit:

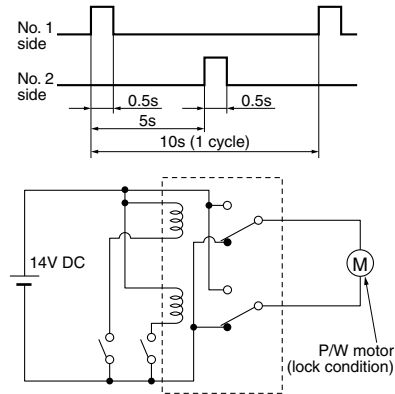

Change of operate (set) and release (reset) voltage

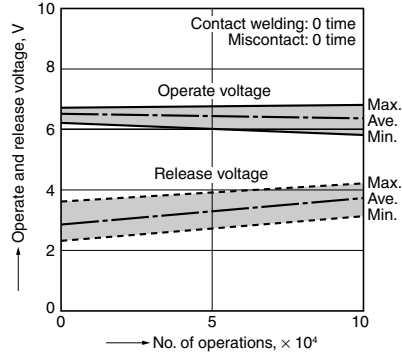

Change of contact resistance

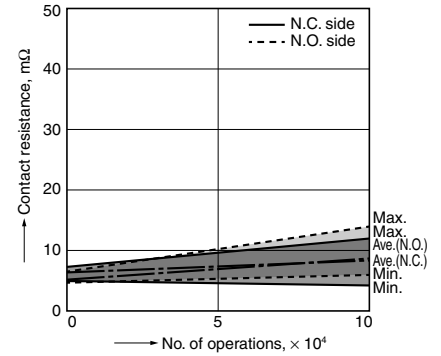

Load current waveform

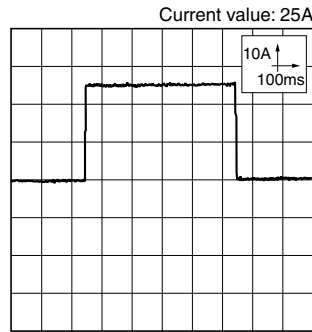

**DIMENSIONS** (mm inch)

1. Twin type (8-pin)  
 Standard type



The CAD data of the products with a **CAD** mark can be downloaded from: <http://industrial.panasonic.com/ac/e/>

External dimensions

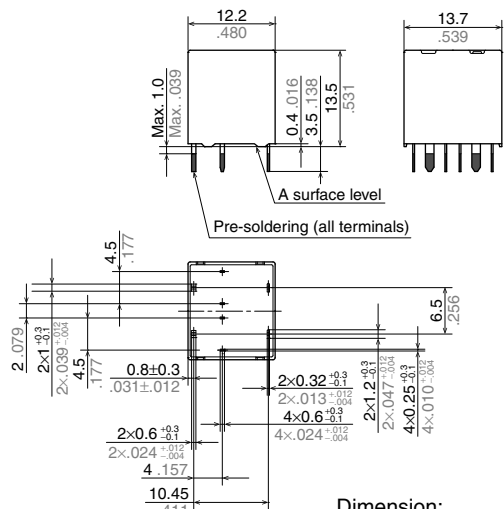

PC board pattern  
 (Bottom view)

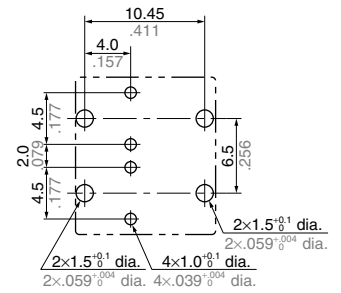

Tolerance: ±0.1 ±.004

Schematic  
 (Bottom view)

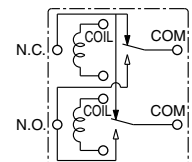

Dimension:  
 Max. 1mm .039 inch: ±0.1 ±.004  
 1 to 3mm .039 to .118 inch: ±0.2 ±.008  
 Min. 3mm .118 inch: ±0.3 ±.012

\* Dimensions (thickness and width) of terminal is measured before pre-soldering.  
 Intervals between terminals is measured at A surface level.

# CJ (ACJ)

## 2. Twin type (8-pin) Pin in Paste compliant type

CAD

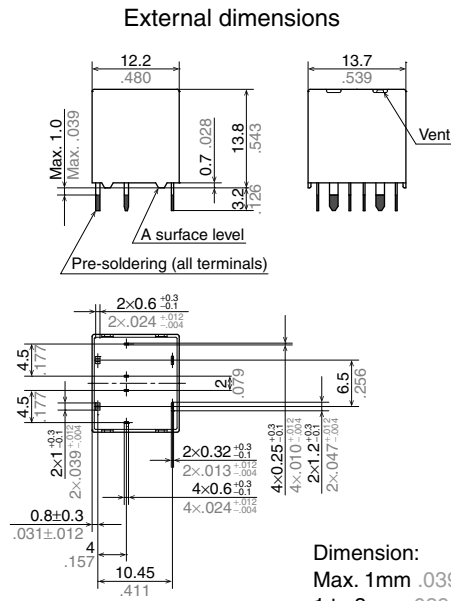

### PC board pattern (Bottom view)

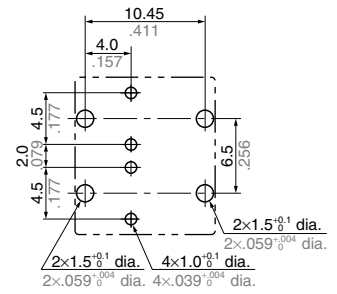

Tolerance:  $\pm 0.1 \pm .004$

### Schematic (Bottom view)

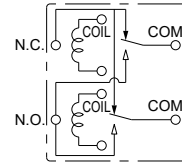

\* Dimensions (thickness and width) of terminal is measured before pre-soldering.  
Intervals between terminals is measured at A surface level.

## 3. Twin type (10-pin) Standard type

CAD

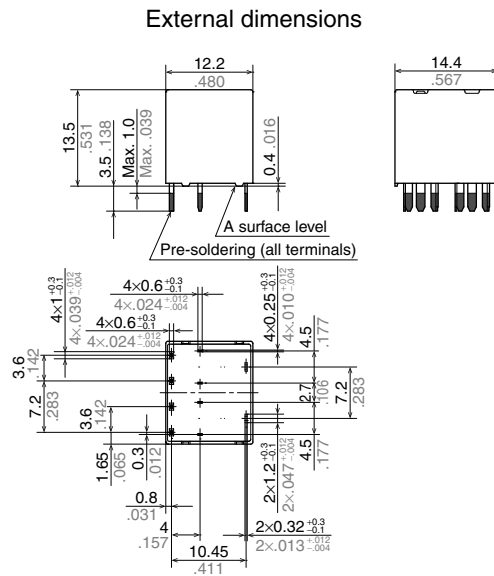

### PC board pattern (Bottom view)

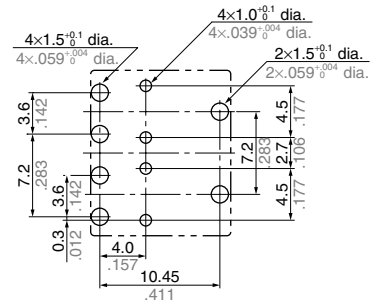

Tolerance:  $\pm 0.1 \pm .004$

### Schematic (Bottom view)

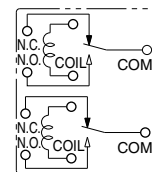

\* Dimensions (thickness and width) of terminal is measured before pre-soldering.  
Intervals between terminals is measured at A surface level.

4. Twin type (10-pin)  
Pin in Paste compliant type

CAD



External dimensions

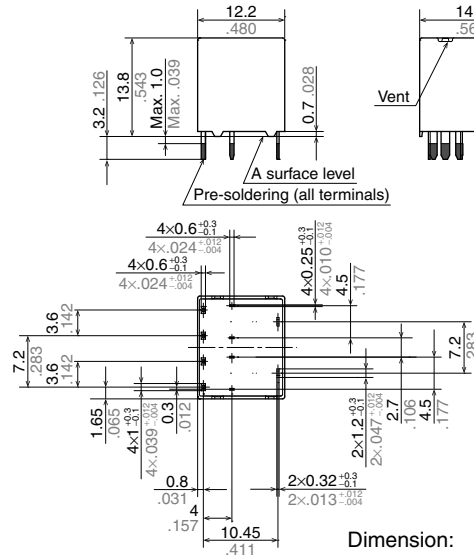

Dimension: Max. 1mm .039 inch:  $\pm 0.1 \pm .004$   
1 to 3mm .039 to .118 inch:  $\pm 0.2 \pm .008$   
Min. 3mm .118 inch:  $\pm 0.3 \pm .012$

PC board pattern (Bottom view)

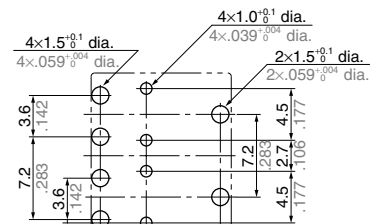

Tolerance:  $\pm 0.1 \pm .004$

Schematic (Bottom view)

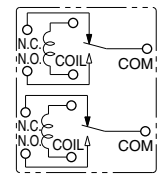

\* Dimensions (thickness and width) of terminal is measured before pre-soldering.  
Intervals between terminals is measured at A surface level.

5. Slim 1 Form C  
Standard type

CAD



External dimensions

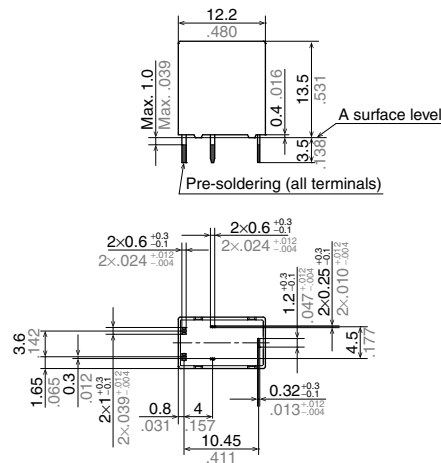

Dimension: Max. 1mm .039 inch:  $\pm 0.1 \pm .004$   
1 to 3mm .039 to .118 inch:  $\pm 0.2 \pm .008$   
Min. 3mm .118 inch:  $\pm 0.3 \pm .012$

PC board pattern (Bottom view)

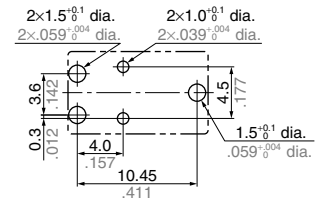

Tolerance:  $\pm 0.1 \pm .004$

Schematic (Bottom view)

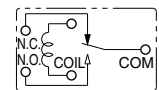

\* Dimensions (thickness and width) of terminal is measured before pre-soldering.  
Intervals between terminals is measured at A surface level.

6. Slim 1 Form C  
Pin in Paste compliant type

CAD



External dimensions

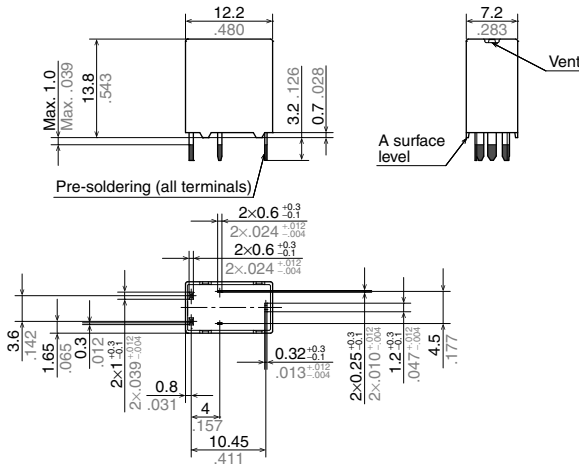

PC board pattern  
(Bottom view)

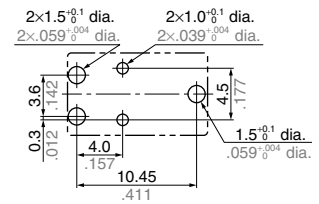

Tolerance:  $\pm 0.1 \pm .004$

Schematic  
(Bottom view)

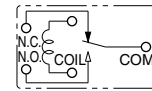

Dimension:	Tolerance
Max. 1mm .039 inch:	$\pm 0.1 \pm .004$
1 to 3mm .039 to .118 inch:	$\pm 0.2 \pm .008$
Min. 3mm .118 inch:	$\pm 0.3 \pm .012$

\* Dimensions (thickness and width) of terminal is measured before pre-soldering.  
Intervals between terminals is measured at A surface level.

NOTES

Mounting and cleaning conditions for Pin-in-Paste type

When soldering this relay, please observe the following conditions.

[I.R.S. method (recommended)]

(Recommended number of reflows: 1)

- t<sub>1</sub> = 60 to 120 sec.
- t<sub>2</sub> = Less than 30 sec.
- t<sub>3</sub> = Less than 5 sec.
- T<sub>1</sub> = 150 to 180°C 302 to 356°F
- T<sub>2</sub> = 230°C 446°F or more
- T<sub>3</sub> = Less than 250°C 482°F

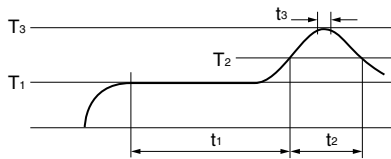

• Cautions for mounting

1. The temperature profile shows the temperature at the soldering portion on the PCB surface.
2. Depending on the mounting density condition, reflow heating method, and PCB type (metal etc.), the relay's exterior and interior temperature may become extremely high.  
Therefore, please confirm well under the actual use condition before use.

The other cautions of reflow soldering:

1. When soldering condition is out of recommendation, the relay performance may be adversely affected.  
If soldering conditions are out of our recommendation, please contact us before operation.
2. Please check the effect at the actual soldering because heat stress to relay is changed by PCB type and manufacturing process condition.
3. Solder creepage, wettability or soldering strength will be affected by the mounting condition or soldering material. Please check the actual production condition in detail.
4. Do not wash the relay as failures may occur.
5. This product is not plastic sealed type. Please perform coating with sufficient attention to avoid infiltration of the solvent to the inside. Also, please pay careful attention to use and store them with no contamination of foreign material.

For general cautions for use, please refer to the "Automotive Relay Users Guide".



---

Please contact .....

**Panasonic Corporation**

Electromechanical Control Business Division

■ 1006, Oaza Kadoma, Kadoma-shi, Osaka 571-8506, Japan  
[industrial.panasonic.com/ac/e/](http://industrial.panasonic.com/ac/e/)

**Panasonic**<sup>®</sup>

©Panasonic Corporation 2017