

Compact Flat Size Relay for Automotive

CP RELAYS

<Protective construction>
Sealed

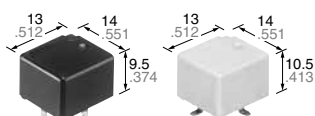

FEATURES

- Compact flat type
<Height> PC board terminal type: 9.5 mm .374 inch
- Compact and High capacity (25A) continuous current (at 20°C 68°F)
- Simple footprint pattern enables ease of PC board layout
- “PC board terminal” and “Surface mount terminal” types available
- Model available for wiper load.

TYPICAL APPLICATIONS

- Powered windows, Automatic door locks, Powered sunroof, Memory seat, Wiper, Defogger, etc.

(Unit: mm inch)

RoHS compliant

ORDERING INFORMATION

CP □ - □ - □ - □

Contact arrangement

- 1: 1 Form C
- 1a: 1 Form A
- 1W: 1 Form C for wiper load

Mounting classification

- Nil: PC board terminal type/wiper load
- SA: Surface-mount terminal type

Rated coil voltage (DC)

12 V

Packing style*

- Nil: Tube packing
- X: Tape and reel packing (picked from the N.C. terminal side)
- Z: Tape and reel packing (picked from the coil terminal side)

Note: * Surface mount terminal type is only supplied in tape and reel packaging. Tube packaging is only available for PC board type.

TYPES

1. PC board terminal type

Contact arrangement	Rated coil voltage	Type No.	Packing	
			Carton (tube)	Case
1 Form A	12V DC	CP1a-12V	40 pcs.	1,000 pcs.
1 Form C		CP1-12V		
1 Form C for wiper load		CP1W-12V		

2. Surface mount terminal type

Contact arrangement	Rated coil voltage	Type No.	Packing	
			Carton (tape and reel)	Case
1 Form C	12V DC	CP1SA-12V-X	300 pcs.	900 pcs.
		CP1SA-12V-Z		

Notes: 1. Surface-mount terminal type is available only for 1 form C contact arrangement.
 2. Surface mount terminal type is only supplied in tape and reel packaging. Tube packaging is only available for PC board type.
 Tape and reel packing symbol "-z" or "-x" are not marked on the relay.

RATING

1. Coil data

Rated coil voltage	Operate (Set) voltage (at 20°C 68°F) (Initial)	Release (Reset) voltage (at 20°C 68°F) (Initial)	Rated operating current [±10%] (at 20°C 68°F)	Coil resistance [±10%] (at 20°C 68°F)	Rated operating power (at 20°C 68°F)	Usable voltage range (at 85°C 185°F)
12V DC	Max. 7.2V DC	Min. 1.0V DC	53.3 mA	225Ω	640 mW	10 to 16V DC

Note: Other operate (set) voltage types are also available. Please inquire our sales representative for details.

2. Specifications

1) Standard CP relay

Item	Specifications	
Contact data	Contact arrangement	1 Form A, 1 Form C
	Contact resistance (initial)	Max. 100mΩ (N.O.: Typ. 6mΩ, N.C.: Typ. 8mΩ) (By voltage drop 1A 6V DC)
	Contact material	Ag alloy
	Rated switching capacity (resistive)	N.O. side: 20A 14V DC, N.C. side: 10A 14V DC
	Max. carrying current (initial)*1 *4	N.O. side: 40A for 2 minutes, 30A for 1 hour (Coil applied voltage 12 V DC, at 20°C 68°F) 35A for 2 minutes, 25A for 1 hour (Coil applied voltage 12 V DC, at 85°C 185°F)
	Min. switching load (resistive)*2	1A 14V DC (at 20°C 68°F)
Insulated resistance (initial)	Min. 100 MΩ (at 500V DC, Measurement at same location as "Dielectric strength" section.)	
Dielectric strength (initial)	Between open contacts	500 Vrms for 1 min. (Detection current: 10mA)
	Between contacts and coil	500 Vrms for 1 min. (Detection current: 10mA)
Time characteristics (initial)	Operate (Set) time (at Rated voltage)	Max. 10ms (at 20°C 68°F, without bounce time)
	Release (Reset) time (at Rated voltage)	Max. 10ms (at 20°C 68°F, without bounce time) (without diode)
Shock resistance	Functional	Min. 100 m/s ² {approx. 10G} (Half-wave pulse of sine wave: 11ms; detection time: 10μs)
	Destructive	Min. 1,000 m/s ² {approx. 100G} (Half-wave pulse of sine wave: 6ms)
Vibration resistance	Functional	10 to 100 Hz, Min. 44.1 m/s ² {approx. 4.5G} (Detection time: 10μs)
	Destructive	10 to 500 Hz, Min. 44.1 m/s ² {approx. 4.5G} Time of vibration for each direction; X, Y direction: 2 hours, Z direction: 4 hours
Expected life	Mechanical	Min. 10 ⁷ (at 120 cpm)
	Electrical*4	<Resistive load> Min. 10 ⁵ (At rated switching capacity, operating frequency: 1s ON, 9s OFF) <Motor load> Min. 2×10 ⁵ (N.O. side, Inrush 25A, steady 5A at 14V DC) Min. 10 ⁵ (N.O. side, 20A 14V DC at motor lock) Min. 2×10 ⁵ (N.C. side, 20A 14V DC at brake current) (Operating frequency: 0.5s ON, 9.5s OFF)
Conditions	Conditions for usage, transport and storage*3 Ambient temperature: -40 to +85°C -40 to +185°F Humidity: 5 to 85% R.H. (Please avoid icing or condensation)	
Weight	Approx. 4g .14 oz	

Notes: *1. Depends on connection conditions. Also, this does not guarantee repeated switching. We recommend that you confirm operation under actual conditions.
 *2. This value can change due to the switching frequency, environmental conditions, and desired reliability level, therefore it is recommended to check this with the actual load.
 *3. The upper operation ambient temperature limit is the maximum temperature that can satisfy the coil temperature rise value. For details, please refer to the "Automotive Relay Users Guide".
 Please inquire if you will be using the relay in a high temperature atmosphere (110°C 230°F).
 *4. For wiper motor load, please see the wiper load specifications, below.

2) For wiper load (CP1W-12V)

Anything outside of that given below complies with standard CP relays.

Item	Specifications
Rating	Max. carrying current (initial)*1 N.O. side: 25A for 1 minutes, 15A for 1 hour (coil applied voltage 12 V DC, at 20°C 68°F)
Expected life	Electrical <Wiper motor load (L = Approx. 1mH) without capacitor> N.O. side: Min. 5×10 ⁵ (Inrush 25A, steady 6A at 14V DC) N.C. side: Min. 5×10 ⁵ (12A 14V DC at brake current) (Operating frequency: 1s ON, 9s OFF)

Note: *1. Depends on connection conditions. Also, this does not guarantee repeated switching. We recommend that you confirm operation under actual conditions.

REFERENCE DATA

1.-(1) Coil temperature rise (at room temperature)

Sample: CP1-12V, 3pcs
 Point measured: Inside the coil
 Carrying current: 5A, 10A, 15A, 20A
 Ambient temperature 26°C 79°F

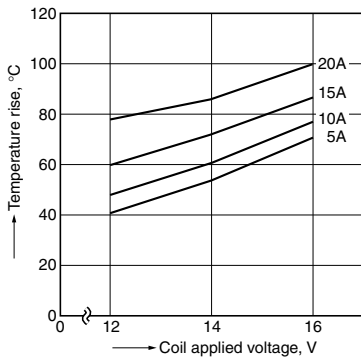

1.-(2) Coil temperature rise (85°C 185°F)

Sample: CP1-12V, 6pcs
 Point measured: Inside the coil
 Carrying current: 5A, 10A, 15A, 20A
 Resistance method, ambient temperature 85°C 185°F

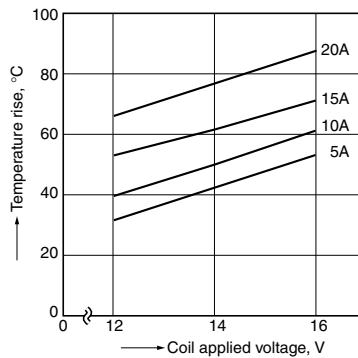

2. Max. switching capability (Resistive load, Initial)

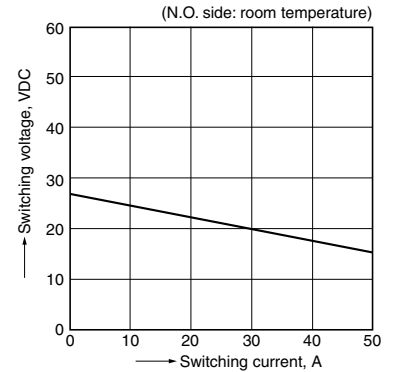

3. Ambient temperature and usable voltage range

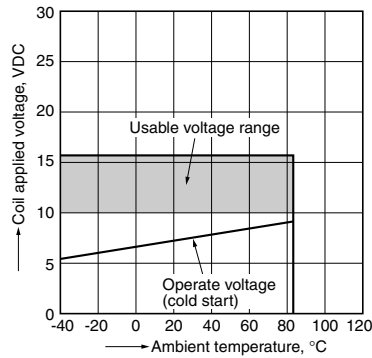

4. Distribution of operate (set) and release (reset) voltage

Sample: CP1-12V, 100pcs
 Ambient temperature: 20°C 68°F

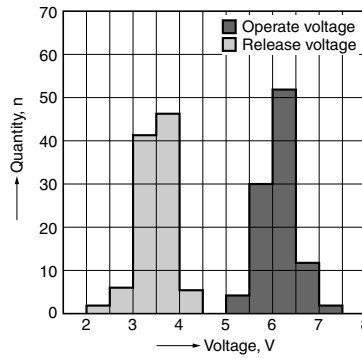

5. Distribution of operate (set) time

Sample: CP1-12V, 100pcs
 Ambient temperature: 20°C 68°F

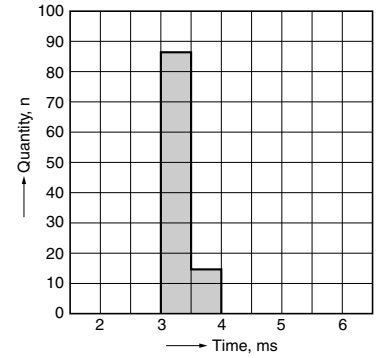

6. Distribution of release (reset) time

Sample: CP1-12V, 100pcs
 Ambient temperature: 20°C 68°F

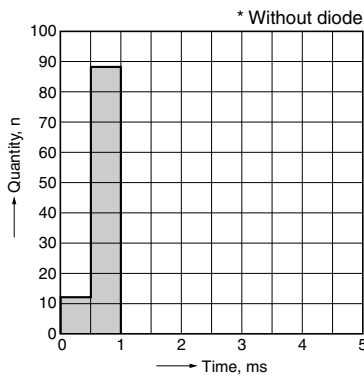

7.-(1) Electrical life test (at resistive load)

Sample: CP1-12V
 Quantity: n = 4 (N.C. = 2, N.O. = 2)
 Load: Resistive load (N.C. side: 10A 14V DC, N.O. side: 20A 14V DC)
 Operating frequency: ON 1s, OFF 9s
 Ambient temperature: Room temperature

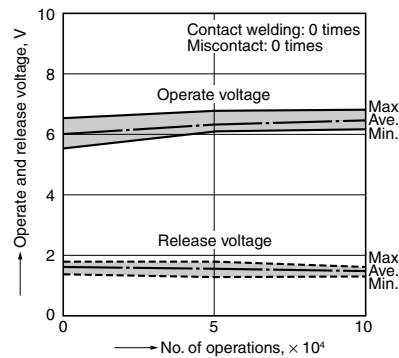

CP (ACP)

7.-(2) Electrical life test for wiper load (motor free)

Sample: CP1W-12V

Quantity: n = 5

Load: N.O. side: Inrush 25A, steady 6A 14V DC

Load: N.C. side: Brake current 12A 14V DC

Operating frequency: ON 1s, OFF 9s

Ambient temperature: Room temperature

Circuit:

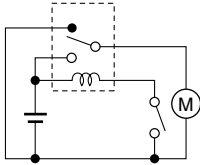

Change of operate (set) and release (reset) voltage

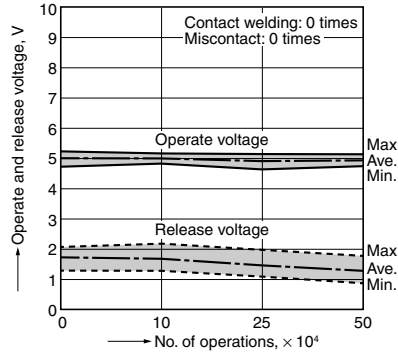

Change of contact resistance

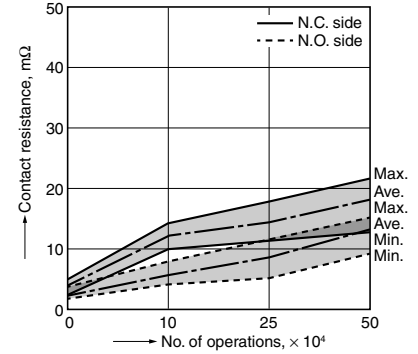

DIMENSIONS (mm inch)

The CAD data of the products with a **CAD** mark can be downloaded from: <http://industrial.panasonic.com/ac/e/>

1. PC board terminal type

CAD



External dimensions

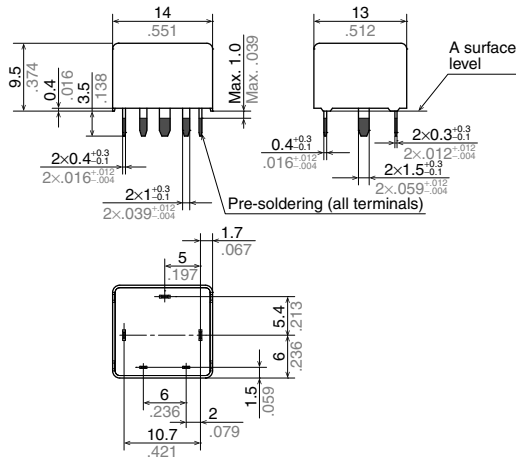

Dimension:	Tolerance
Max. 1mm .039 inch:	$\pm 0.1 \pm .004$
1 to 3mm .039 to .118 inch:	$\pm 0.2 \pm .008$
Min. 3mm .118 inch:	$\pm 0.3 \pm .012$

PC board pattern (Bottom view)

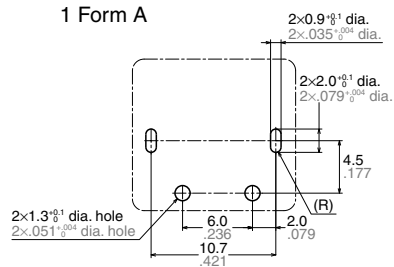

1 Form C

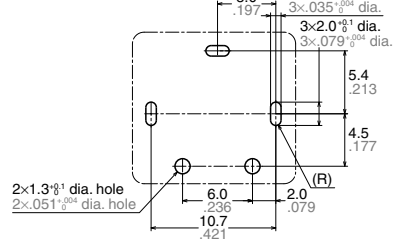

Tolerance: $\pm 0.1 \pm .004$

Schematic (Bottom view)

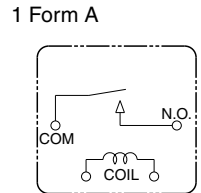

1 Form C

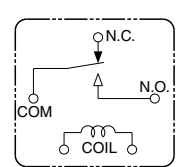

* Dimensions (thickness and width) of terminal specified in this catalog is measured after pre-soldering. Intervals between terminals is measured at A surface level.

2. Surface mount terminal type

CAD



External dimensions

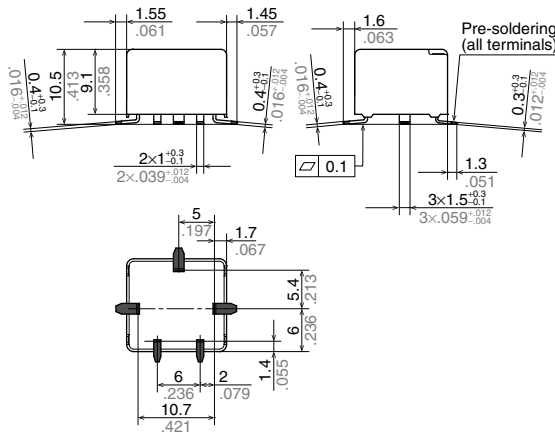

Dimension:	Tolerance
Max. 1mm .039 inch:	$\pm 0.1 \pm .004$
1 to 3mm .039 to .118 inch:	$\pm 0.2 \pm .008$
Min. 3mm .118 inch:	$\pm 0.3 \pm .012$

Recommendable mounting pad (Top view)

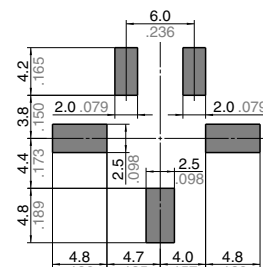

Tolerance: $\pm 0.1 \pm .004$

Schematic (Top view)

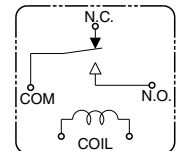

NOTES

1. Mounting and cleaning conditions for Surface-mount terminal type relays

When soldering this relay, please observe the following conditions.

(Recommended conditions: Number of reflows: 1, Measurement location: terminal temperature)

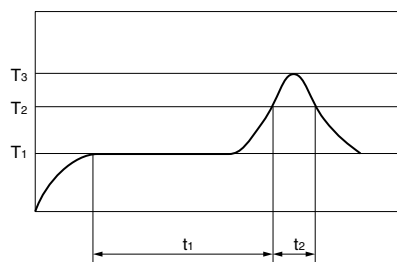

T₁ = 150 to 180°C 302 to 356°F
 T₂ = 230°C 446°F or more
 T₃ = Less than 250°C 482°F
 t₁ = 60 to 120 sec.
 t₂ = Less than 30 sec.

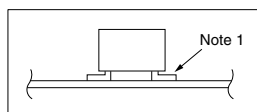

Temperature profile indicates the temperature of the soldered part (Note 1) of terminals on the surface of the PC board, however, for other areas such as the surface of relay case, make a setting so that you do not exceed the recommended conditions.

*The temperature of the relay exterior and interior may be extremely high depending on the component density on the board, the heating method of the reflow oven or circuit board type.

Other cautions during reflow soldering

- (1) Reflow performance may be affected if you carry out soldering in a way that exceeds the recommended conditions. If you need to exceed the recommended conditions when soldering, please inquire our sales representative before using in an application.
- (2) Please confirm the heat stress of relay by using actual board because it may be changed by board condition or manufacturing process condition.
- (3) Solder creepage, wettability, or soldering strength will be affected by the changing of soldering condition or used solder type. Please check them under the actual production condition in detail.
- (4) Avoid cleaning (ultrasonic cleaning, boiling cleaning, etc.) and coating in order to prevent negative impacts on relay characteristics.

2. Storage condition after opening a moisture-prevention package

- 1) After opening a moisture-prevention package, use the item as soon as possible (within 4 days under an environment of Max. 30°C 86°F, Max. 70% RH).
- 2) If products are not used within 4 days after opening a moisture-prevention package, store them in a humidity-controlled desiccator or in a storage bag with silica gel.

For general cautions for use, please refer to the “Automotive Relay Users Guide”.

Please contact

Panasonic Corporation

Electromechanical Control Business Division

■ 1006, Oaza Kadoma, Kadoma-shi, Osaka 571-8506, Japan
industrial.panasonic.com/ac/e/

Panasonic[®]

©Panasonic Corporation 2017