

TC RELAYS

High load relay for Smart J/B

< Protective construction >

Standard type / High heat - resistant type: Sealed
Pin in Paste compliant type: Flux tight

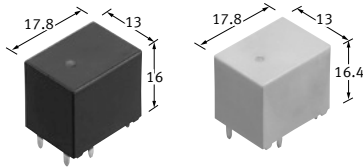

(Unit: mm)

FEATURES

- Large capacity switching despite small size. Can replace micro ISO terminal type relays.
- Latching type added.
- Pin in Paste compliant model added.

TYPICAL APPLICATIONS

- Head lamp, Fog lamp, Fan motor, Defogger and Seat heater, etc.

ORDERING INFORMATION (PART NO.)

ACTC

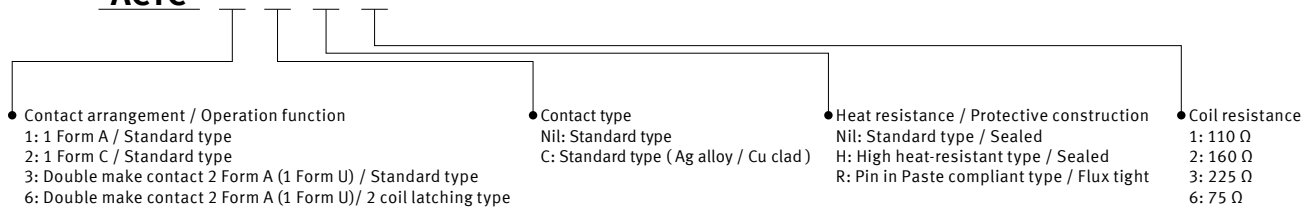

Automotive Relays TC RELAYS

TYPES

Contact arrangement/ Operational function	Contact type	Rated coil voltage	Coil resistance	Part No.			Packing	
				Heat resistance			Carton (1-tube)	Case
				Standard type	High-heat resistant type	Pin in Paste compliant type		
1 Form A/ Standard type	Standard type	12 V DC	110 Ω	ACTC11	ACTC1H1	ACTC1R1	40 pcs.	800 pcs.
			160 Ω	ACTC12	ACTC1H2	ACTC1R2		
			225 Ω	ACTC13	ACTC1H3	ACTC1R3		
	Standard type (Ag alloy / Cu clad)		110 Ω	ACTC1C1	ACTC1CH1	ACTC1CR1		
			160 Ω	ACTC1C2	ACTC1CH2	ACTC1CR2		
			225 Ω	ACTC1C3	ACTC1CH3	ACTC1CR3		
1 Form C/ Standard type	Standard type		110 Ω	ACTC21	ACTC2H1	ACTC2R1		
			160 Ω	ACTC22	ACTC2H2	ACTC2R2		
			225 Ω	ACTC23	ACTC2H3	ACTC2R3		
	Standard type (Ag alloy / Cu clad)		110 Ω	ACTC2C1	ACTC2CH1	ACTC2CR1		
			160 Ω	ACTC2C2	ACTC2CH2	ACTC2CR2		
			225 Ω	ACTC2C3	ACTC2CH3	ACTC2CR3		
Double make contact 2 Form A (1 Form U) / Standard type	Standard type	110 Ω	ACTC31	ACTC3H1	ACTC3R1			
		160 Ω	ACTC32	ACTC3H2	ACTC3R2			
	Standard type (Ag alloy / Cu clad)	110 Ω	ACTC3C1	ACTC3CH1	ACTC3CR1			
		160 Ω	ACTC3C2	ACTC3CH2	ACTC3CR2			
Double make contact 2 Form A (1 Form U) / 2 coil latching type	Standard type	75 Ω	ACTC66	ACTC6H6	ACTC6R6			
		75 Ω	ACTC6C6	ACTC6CH6	ACTC6CR6			

RATING

Coil data

1) Standard type

Rated coil voltage	Operate (Set) voltage (at 20°C)(Initial)	Release (Reset) voltage (at 20°C)(Initial)	Rated operating current [±10%] (at 20°C)	Coil resistance [±10%] (at 20°C)	Rated operating power (at 20°C)	Usable voltage range
12 V DC	Max. 6.5 V DC	Min. 0.5 V DC	109 mA	110 Ω	1,309 mW	10 to 16 V DC
	Max. 7.0 V DC		75 mA	160 Ω	900 mW	
	Max. 7.5 V DC		53.3 mA	225 Ω	640 mW	

Note: Other operate (set) voltage types are also available. Please inquire our sales representative for details.

2) 2 coil latching type

Rated coil voltage	Operate (Set) voltage (at 20°C)(Initial)	Release (Reset) voltage (at 20°C)(Initial)	Rated operating current [±10%] (at 20°C)		Coil resistance [±10%] (at 20°C)		Rated operating power (at 20°C)		Usable voltage range
			Set coil	Reset coil	Set coil	Reset coil	Set coil	Reset coil	
12 V DC	Max. 7.2 V DC	Max. 7.2 V DC	160 mA	160 mA	75 Ω	75 Ω	1,920 mW	1,920 mW	10 to 16 V DC

Specifications

Item	Specifications	
Contact data	Contact arrangement	1 Form A, 1 Form C, Double make contact 2 Form A (1 Form U)
	Contact resistance (initial)	Max. 50 mΩ (N.O. side: typ. 3 mΩ, N.C. side: typ. 4 mΩ) (by voltage drop 1 A 6 V DC)
	Contact material	Ag alloy
	Rated switching capacity (resistive)	N.O. side: 30 A 14 V DC, N.C. side: 15 A 14 V DC
	Max. carrying current (initial)*1	35 A/1 hour (Coil applied voltage 12 V DC, at 20°C)
	Min. switching load (resistive)*2	1 A 14 V DC (at 20°C)
Insulated resistance (initial)	Min. 100 MΩ (at 500 V DC, Measurement at same location as "Dielectric strength" section)	
Dielectric strength (initial)	Between open contacts	500 Vrms for 1 min (detection current: 10 mA)
	Between contact and coil	500 Vrms for 1 min (detection current: 10 mA)
Time characteristics (initial)	Operate (Set) time (at rated voltage)	Max. 10 ms (at 20°C, without contact bounce time)
	Release (Reset) time (at rated voltage)	Max. 10 ms (at 20°C, without contact bounce time) (without diode)
Shock resistance	Functional	Min. 100 m/s ² {approx. 10 G} (half-wave pulse of sine wave: 11 ms, detection time: 10 μs)
	Destructive	Min. 1,000 m/s ² {approx. 100 G} (half-wave pulse of sine wave: 6 ms)
Vibration resistance	Functional	10 to 100 Hz, Min. 44.1 m/s ² {approx. 4.5 G} (detection time: 10 μs)
	Destructive	10 to 500 Hz, Min. 44.1 m/s ² {approx. 4.5 G} Time of vibration for each direction; X, Y direction: 2 hours, Z direction: 4 hours
Expected life	Mechanical	Min. 10 ⁷ (120 times/min) Min. 10 ⁶ (120 times/min) (2 coil latching type)
	Electrical*4	<Resistive load> Min. 10 ⁵ at rated switching capacity Operating frequency: ON 1 s, OFF 9 s <Motor load> Min. 10 ⁵ 30 A 14 V DC at motor lock condition Operating frequency: ON 0.5 s, OFF 9.5 s <Lamp load> Min. 2 x 10 ⁵ at 84 A (inrush), 12 A (steady) 14 V DC Operating frequency: ON 1 s, OFF 14 s
Conditions	Standard type High heat-resistant/Pin in Paste compliant type	Ambient temperature: -40 to +85°C, Humidity: 5 to 85% RH Ambient temperature: -40 to +110°C, Humidity: 2 to 85% RH (Avoid icing or condensation)
Unit weight	Approx. 10 g	

Note: *1. Depends on connection conditions. Also, this does not guarantee repeated switching. We recommend that you confirm operation under actual conditions.
 *2. This value can change due to the switching frequency, environmental conditions, and desired reliability level, therefore it is recommended to check this with the actual load.
 *3. The upper operation ambient temperature limit is the maximum temperature that can satisfy the coil temperature rise value. For details, please refer to the "Automotive Relay Users Guide".
 Please inquire our sales representative if you will be using the relay in a high temperature atmosphere (110°C).
 *4. Please connect COM to the "+ (plus)" side.

REFERENCE DATA

1-1. Coil temperature rise (at room temperature)

Sample: ACTC12, 3 pcs.
 Carrying current: 10 A, 20 A, 30 A
 Ambient temperature: Room temperature

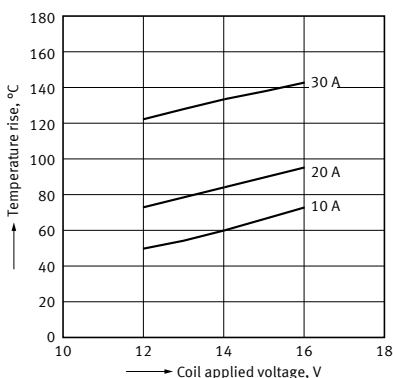

1-2. Coil temperature rise (at 85°C)

Sample: ACTC12, 3 pcs.
 Carrying current: 10 A, 20 A
 Ambient temperature: 85°C

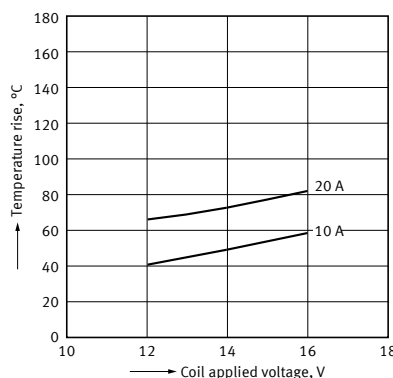

2. Ambient temperature and usable voltage range

Sample: ACTC12

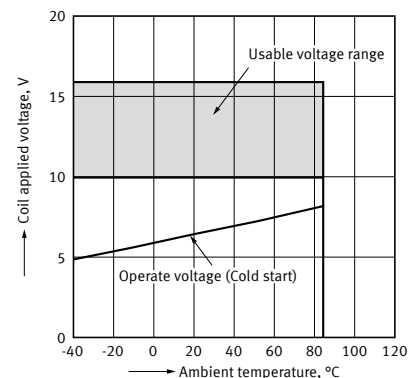

Automotive Relays TC RELAYS

3. Distribution of operate (set) and release (reset) voltage

Sample: ACTC12, 40 pcs.

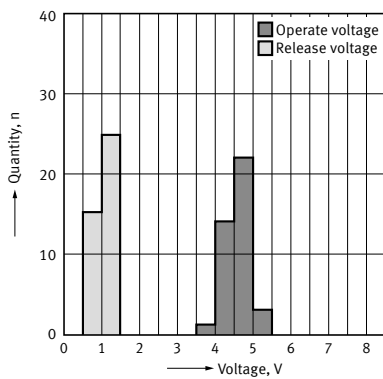

4. Distribution of operate (set) and release (reset) time

Sample: ACTC12, 40 pcs.

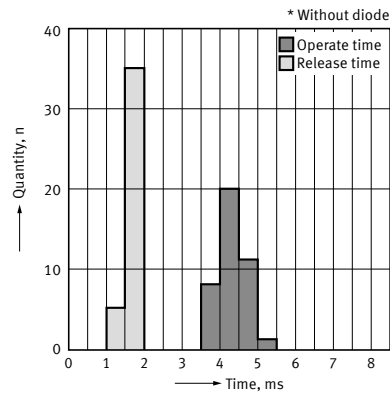

5-1. Electrical life test (Motor lock)

Sample: ACTC12, 6 pcs.
 Load: 30 A 14 V DC
 Motor load (lock condition)
 Operating frequency: ON 0.5 s, OFF 9.5 s
 Ambient temperature: Room temperature
 Circuit:

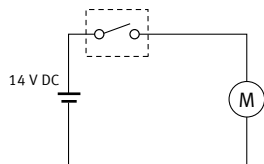

Change of operate (set) and release (reset) voltage

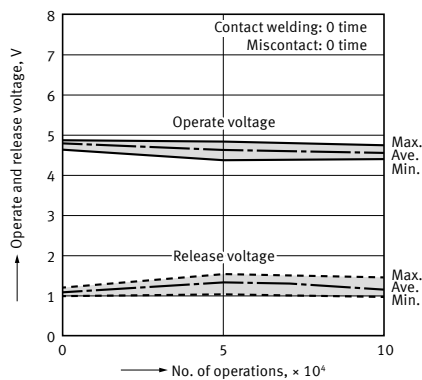

Change of contact resistance

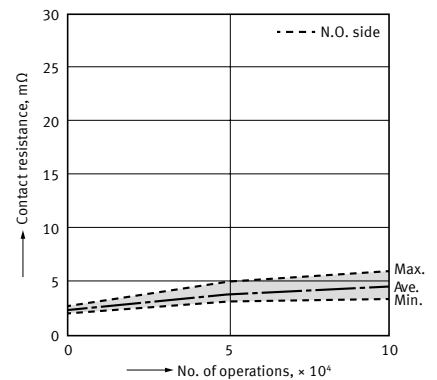

5-2. Electrical life test (Lamp load)

Sample: ACTC12, 6 pcs.
 Load: inrush current: 84 A, steady current: 12 A 14 V DC
 DC
 Operating frequency: ON 1 s, OFF 14 s
 Ambient temperature: Room temperature
 Circuit:

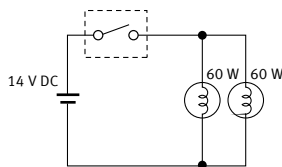

Change of operate (set) and release (reset) voltage

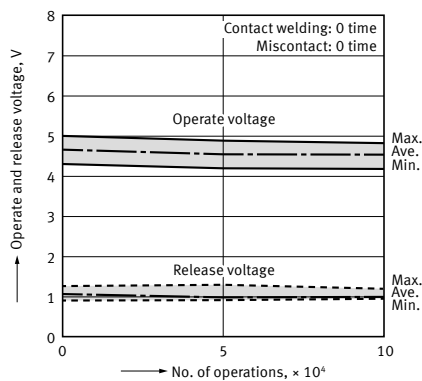

Change of contact resistance

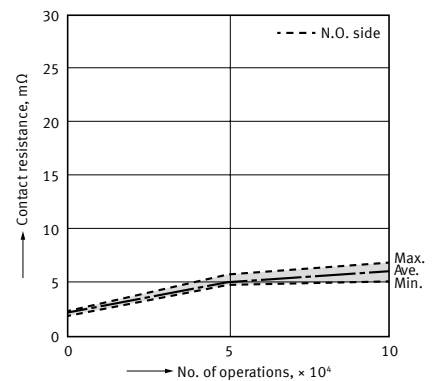

DIMENSIONS

CAD The CAD data of the products with a "CAD" mark can be downloaded from our Website.

Unit: mm

1 Form A / Standard type

CAD



External dimensions

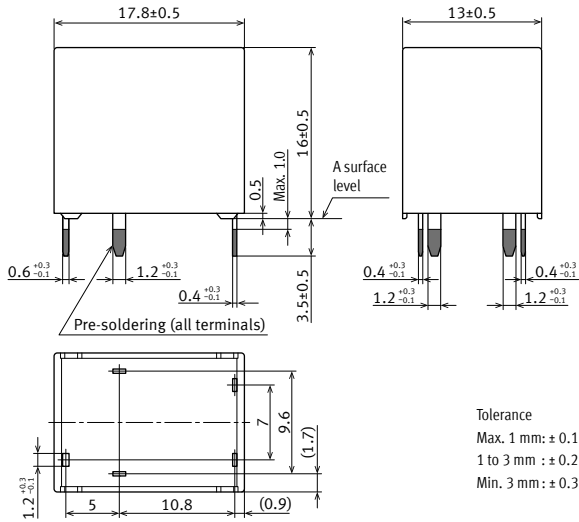

PC board pattern (BOTTOM VIEW)

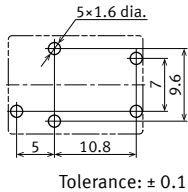

Schematic (BOTTOM VIEW)

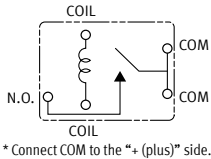

Tolerance
 Max. 1 mm: ± 0.1
 1 to 3 mm : ± 0.2
 Min. 3 mm : ± 0.3

* Dimensions (thickness and width) of terminal is measured after pre-soldering.
 Intervals between terminals is measured at A surface level.

1 Form C / Standard type

CAD



External dimensions

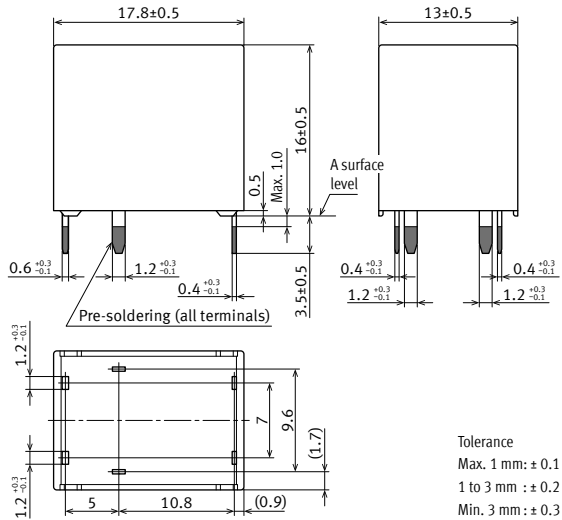

PC board pattern (BOTTOM VIEW)

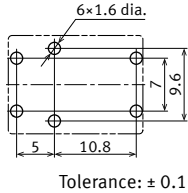

Schematic (BOTTOM VIEW)

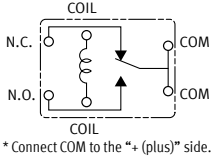

Tolerance
 Max. 1 mm: ± 0.1
 1 to 3 mm : ± 0.2
 Min. 3 mm : ± 0.3

* Dimensions (thickness and width) of terminal is measured after pre-soldering.
 Intervals between terminals is measured at A surface level.

Automotive Relays TC RELAYS

Double make contact 2 Form A (1 Form U) / Standard type

CAD



External dimensions

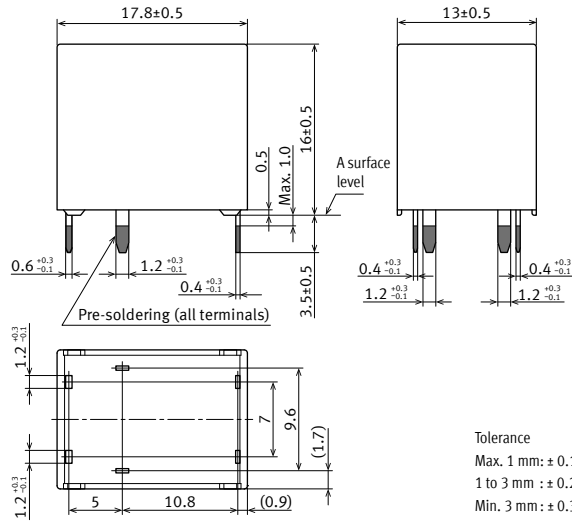

* Dimensions (thickness and width) of terminal is measured after pre-soldering.
 Intervals between terminals is measured at A surface level.

PC board pattern (BOTTOM VIEW)

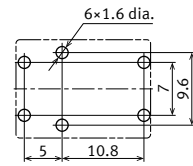

Tolerance: ± 0.1

Schematic (BOTTOM VIEW)

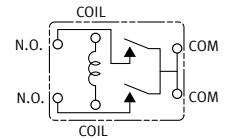

* Connect COM to the "+" (plus)" side.

Double make contact 2 Form A (1 Form U) / 2 coil latching type

CAD



External dimensions

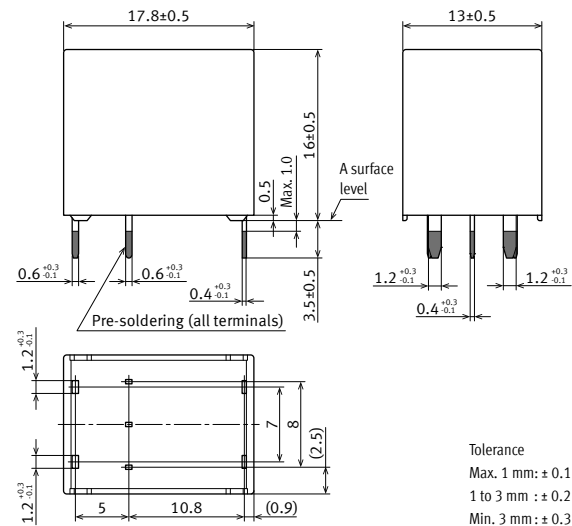

* Dimensions (thickness and width) of terminal is measured after pre-soldering.
 Intervals between terminals is measured at A surface level.

PC board pattern (BOTTOM VIEW)

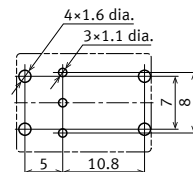

Tolerance: ± 0.1

Schematic (BOTTOM VIEW)

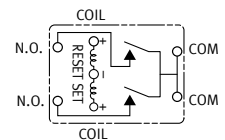

* Connect COM to the "+" (plus)" side.

■ 1 Form A / Standard type

● Pin in Paste compliant type

CAD



External dimensions

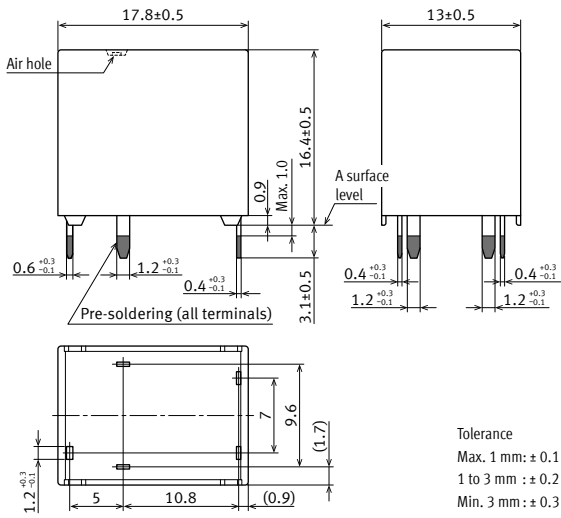

Tolerance
 Max. 1 mm: ± 0.1
 1 to 3 mm : ± 0.2
 Min. 3 mm : ± 0.3

* Dimensions (thickness and width) of terminal is measured after pre-soldering.
 Intervals between terminals is measured at A surface level.

PC board pattern (BOTTOM VIEW)

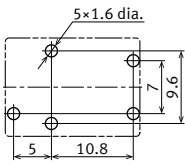

Tolerance: ± 0.1

Schematic (BOTTOM VIEW)

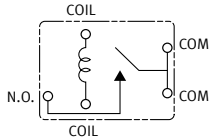

* Connect COM to the "+ (plus)" side.

■ 1 Form C / Standard type

● Pin in Paste compliant type

CAD



External dimensions

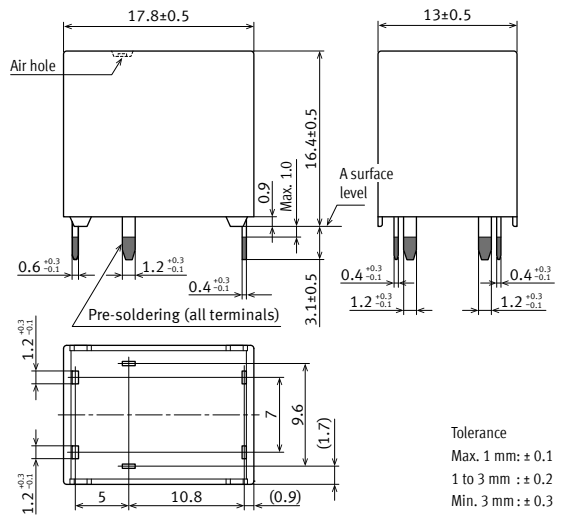

Tolerance
 Max. 1 mm: ± 0.1
 1 to 3 mm : ± 0.2
 Min. 3 mm : ± 0.3

* Dimensions (thickness and width) of terminal is measured after pre-soldering.
 Intervals between terminals is measured at A surface level.

PC board pattern (BOTTOM VIEW)

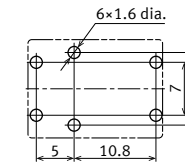

Tolerance: ± 0.1

Schematic (BOTTOM VIEW)

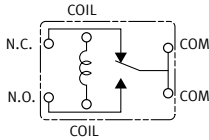

* Connect COM to the "+ (plus)" side.

Automotive Relays TC RELAYS

Double make contact 2 Form A (1 Form U) / Standard type

- Pin in Paste compliant type

CAD



External dimensions

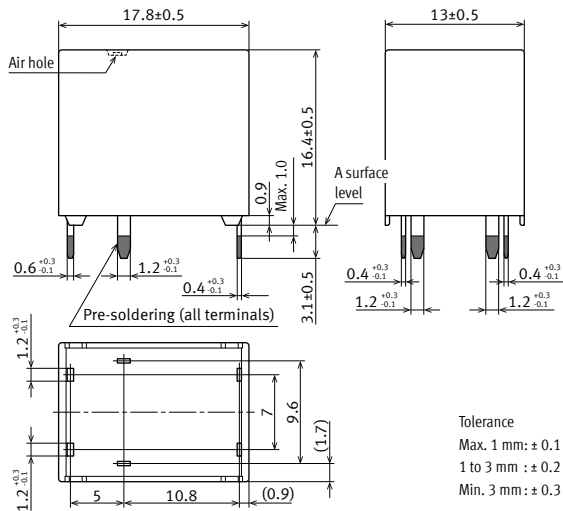

* Dimensions (thickness and width) of terminal is measured after pre-soldering.
 Intervals between terminals is measured at A surface level.

PC board pattern (BOTTOM VIEW)

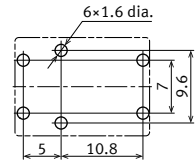

Tolerance: ± 0.1

Schematic (BOTTOM VIEW)

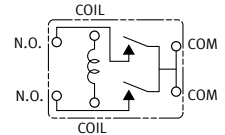

* Connect COM to the "+" (plus)" side.

Double make contact 2 Form A (1 Form U) / 2 coil latching type

- Pin in Paste compliant type

CAD



External dimensions

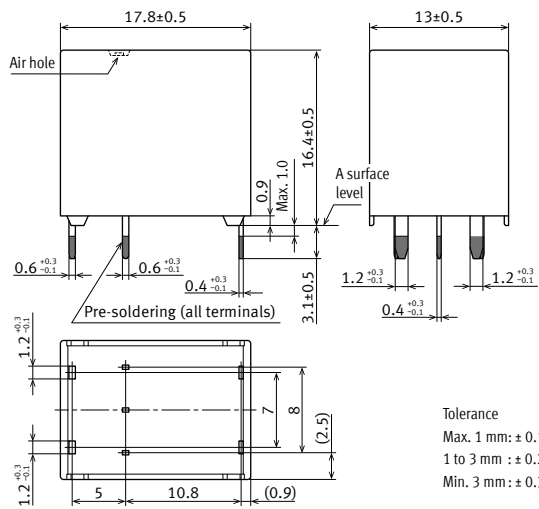

* Dimensions (thickness and width) of terminal is measured after pre-soldering.
 Intervals between terminals is measured at A surface level.

PC board pattern (BOTTOM VIEW)

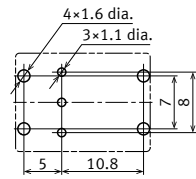

Tolerance: ± 0.1

Schematic (BOTTOM VIEW)

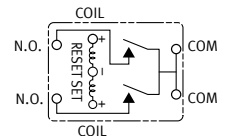

* Connect COM to the "+" (plus)" side.

GUIDELINES FOR USAGE

■ For general cautions for use, please refer to the "Automotive Relay Users Guide".

■ Precautions when using TC relays

● Coil operating power

Pure DC current should be applied to the coil. If it includes ripple, the ripple factor should be less than 5%. However, check it with the actual circuit since the characteristics may be slightly different. Also, the power waveform should be rectangular.

● Coil applied voltage

To ensure proper operation, the voltage applied to the coil should be the rated operating voltage of the coil. Also, be aware that the pick-up and drop-out voltages will fluctuate depending on the ambient temperature and operating conditions.

● Expected life

Check this with the real device as it is affected by coil driving circuit, load type, activation frequency, activation phase, ambient conditions and other factors.

● Soldering

We recommend the relays, ensure conformance with the conditions listed labels.

Automatic soldering

Conditions	Preheating	Soldering
Temperature	Max. 100°C (surface of PC board)	Max. 260°C
Time	within 120 s	within 5 s

● Usage, transport and storage conditions

1) Ambient temperature, humidity and air pressure during usage, transport, and storage of the relay

- (1) Temperature: -40 to +85°C (Standard type)
-40 to +110°C
(High heat-resistant/Pin in Paste compliant type)
- (2) Humidity: 2 to 85% RH (Avoid icing and condensation)
- (3) Air pressure: 86 to 106 kPa

The humidity range varies with the temperature. Use within the range indicated in the graph.

[Temperature and humidity range for usage, transport, and storage]

Standard type

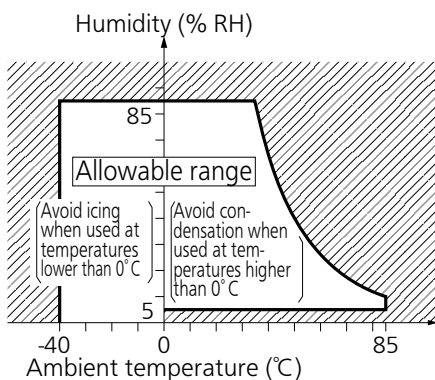

High heat-resistant type

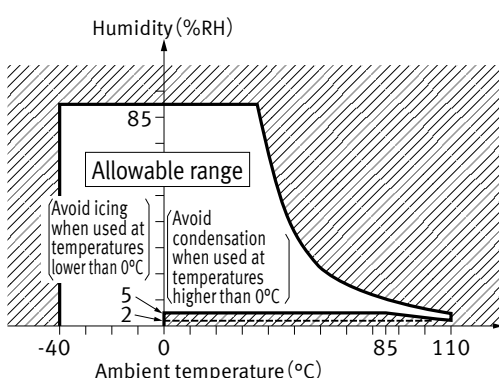

2) Water condensation

Water condensation occurs when the ambient temperature drops suddenly from a high temperature and humidity, or the relay is suddenly transferred from a low ambient temperature to a high temperature and humidity. Condensation causes the failures like insulation deterioration, wire disconnection and rust etc. Panasonic Corporation does not guarantee the failures caused by condensation. The heat conduction by the equipment may accelerate the cooling of relay itself, and the condensation may occur. Please confirm no condensation in the worst condition of the actual usage. (Special attention should be paid when high temperature heating parts are close to the relay. Also, please consider the condensation may occur inside of the relay.)

3) Icing

Please check the icing when an ambient temperature is lower than 0°C. Icing means, the moisture contained in the surrounding environment and inside the relay freezes when the ambient temperature falls below the freezing point. The icing causes the sticking of movable portion, the operation delay and the contact conduction failure etc. Panasonic Corporation does not guarantee the failures caused by the icing. The heat conduction by the equipment may accelerate the cooling of relay itself and the icing may occur. Icing condition is changed by ambient environment, please make sure to confirm no icing in the worst condition of the actual usage

4) Low temperature and low humidity environments

The plastic becomes brittle if the relay is exposed to a low temperature, low humidity environment for long periods of time.

5) Following is the conditions of ambient temperature and humidity in case of tube packaging

- 1) Ambient temperature; 0°C to 40°C (not condensation)
- 2) Humidity; Max. 85% RH

Automotive Relays TC RELAYS

- Mounting and cleaning conditions for Pin in Paste compliant type

When soldering this relay, please observe the following conditions.

[I.R.S method (recommended)]

(Recommended number of reflow: 1 time)

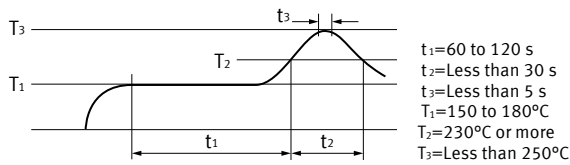

1) Cautions for mounting

- (1) The temperature profile shows the temperature at the soldering portion on the PC board surface.
- (2) Depending on the mounting density condition, reflow heating method, and PC board type (metal etc.), the relay's exterior and interior temperature may become extremely high.
Therefore, please confirm well under the actual use condition before use.

2) The other cautions of reflow soldering:

- (1) When soldering condition is out of recommendation, the relay performance may be adversely affected. If soldering conditions are out of our recommendation, please contact our sales representative before operation.
- (2) Please check the effect at the actual soldering because heat stress to relay is changed by PC board type and manufacturing process condition.
- (3) Solder creepage, wettability or soldering strength will be affected by the mounting condition or soldering material. Please check the actual production condition in detail.
- (4) Do not wash the relay as failures may occur.
- (5) This product is not plastic sealed type. Please perform coating with sufficient attention to avoid infiltration of the solvent to the inside. Also, please pay careful attention to use and store them with no contamination of foreign material.

PRECAUTIONS FOR LATCHING RELAYS

- Latching relays are shipped from the factory in the reset state. A shock to the relay during shipping or installation may cause it to change to the set state.
Therefore, it is recommended that the relay be used in a circuit which initializes the relay to the required state (reset) whenever the power is turned on.
- Avoid impressing voltages to the set coil and reset coil at the same time.
- The positive "+" and negative "-" connections to the coil should be done as indicated on the wiring diagram. If connected incorrectly, it may malfunction or fail to operate.
- In order to cause setting and resetting of the latching relay, apply the rated square wave voltage using as a guide 5 times or more for the set time or the reset time of each product. Furthermore, please verify operation.
- Other handling precautions
Do not use relays that have been dropped, because doing so may be cause of faulty operation.

Please refer to **"the latest product specifications"** when designing your product.
•Requests to customers:
<https://industrial.panasonic.com/ac/e/salespolicies/>

Please contact

Panasonic Corporation

Electromechanical Control Business Division

■1006, Oaza Kadoma, Kadoma-shi, Osaka 571-8506, Japan
industrial.panasonic.com/ac/e/

Panasonic[®]

©Panasonic Corporation 2021