

High Load Relay for Smart J/B

TG RELAYS

<Protective construction>
High heat-resistant type: Sealed

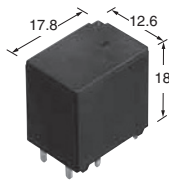

(Unit: mm)

RoHS compliant

FEATURES

- Large capacity switching despite small size. Can replace micro ISO terminal type relays.
- Low operating power type

TYPICAL APPLICATIONS

- Head lamp, Fog lamp, Fan motor, Defogger, Seat heater, etc.

ORDERING INFORMATION

ACTG

Contact arrangement

1: 1 Form A

2: 1 Form C

Contact type

Nil: Standard type

C: Standard type (Ag alloy / Cu clad)

Heat resistance/Protective construction

H: High heat-resistant type/Sealed

Coil resistance

3: 225Ω

4: 320Ω

TYPES

Contact arrangement	Contact type	Rated coil voltage	Coil resistance	Part No.	Packing	
				Heat resistance: High heat-resistant type	Carton (tube)	Case
1 Form A	Standard type	12V DC	225Ω	ACTG1H3	40 pcs.	800 pcs.
			320Ω	ACTG1H4		
	Standard type (Ag alloy / Cu clad)		225Ω	ACTG1CH3		
			320Ω	ACTG1CH4		
1 Form C	Standard type		225Ω	ACTG2H3		
			320Ω	ACTG2H4		
	Standard type (Ag alloy / Cu clad)		225Ω	ACTG2CH3		
			320Ω	ACTG2CH4		

Note: Please inquire our sales representative for details about products other than those above.

RATING

1. Coil data

Rated coil voltage	Operate (Set) voltage (at 20°C) (Initial)	Release (Reset) voltage (at 20°C) (Initial)	Rated operating current [$\pm 10\%$] (at 20°C)	Coil resistance [$\pm 10\%$] (at 20°C)	Rated operating power (at 20°C)	Usable voltage range
12V DC	Max. 6.5V DC	Min. 0.8V DC	53.3 mA	225Ω	640 mW	10 to 16V DC
	Max. 7.0V DC	Min. 0.8V DC	37.5 mA	320Ω	450 mW	

Note: Other operate (set) voltage types are also available. Please inquire our sales representative for details.

2. Specifications

Item		Specifications
Contact data	Contact arrangement	1 Form A, 1 Form C
	Contact resistance (initial)	Max. 50mΩ (N.O. side: typ. 3mΩ, N.C. side: typ. 4mΩ) (By voltage drop 1A 6V DC)
	Contact material	Ag alloy
	Rated switching capacity (resistive)	N.O. side: 30A 14V DC, N.C. side: 15A 14V DC
	Max. carrying current (initial)*1	35A for 1 hour (Coil applied voltage 12V DC, at 20°C)
	Min. switching load (resistive)*2	1A 14V DC (at 20°C)
Insulated resistance (initial)		Min. 100 MΩ (at 500V DC, Measurement at same location as "Dielectric strength" section.)
Dielectric strength (initial)	Between open contacts	500 Vrms for 1 min. (Detection current: 10mA)
	Between contacts and coil	500 Vrms for 1 min. (Detection current: 10mA)
Time characteristics (initial)	Operate (Set) time (at rated voltage)	Max. 10ms (at 20°C, without contact bounce time)
	Release (Reset) time (at rated voltage)	Max. 10ms (at 20°C, without contact bounce time) (Without diode)
Shock resistance	Functional	Min. 100 m/s ² {approx. 10G} (Half-wave pulse of sine wave: 11ms; detection time: 10μs)
	Destructive	Min. 1,000 m/s ² {approx. 100G} (Half-wave pulse of sine wave: 6ms)
Vibration resistance	Functional	10 to 100 Hz, Min. 44.1 m/s ² {approx. 4.5G} (Detection time: 10μs)
	Destructive	10 to 500 Hz, Min. 44.1 m/s ² {approx. 4.5G}, Time of vibration for each direction; X, Y direction: 2 hours, Z direction: 4 hours
Expected life	Mechanical	Min. 10 ⁷ (at 120 cpm)
	Electrical	<Resistive load> Min. 10 ⁵ at rated switching capacity, operating frequency: 1s ON, 9s OFF <Motor load> Min. 10 ⁵ 30 A 14V DC at motor lock condition, operating frequency: 0.5s ON, 9.5s OFF <Lamp load> Min. 2 × 10 ⁵ at 84 A (inrush), 12 A (steady), 14 V DC, Operating frequency: 1s ON, 14s OFF
Conditions	Conditions for usage, transport and storage*3	Ambient temperature: -40 to +110°C, Humidity: 2 to 85% R.H. (Please avoid icing or condensation)
Weight		Approx. 12 g

Notes: *1. Depends on connection conditions. Also, this does not guarantee repeated switching. We recommend that you confirm operation under actual conditions.

*2. This value can change due to the switching frequency, environmental conditions, and desired reliability level, therefore it is recommended to check this with the actual load.

*3. The upper operation ambient temperature limit is the maximum temperature that can satisfy the coil temperature rise value. For details, please refer to the "Automotive Relay Users Guide".

Please inquire our sales representative if you will be using the relay in a high temperature atmosphere (110°C).

REFERENCE DATA

1.-(1) Coil temperature rise (at room temperature)

Sample: ACTG1H4, 3pcs.
Carrying current: 10A, 20A, 30A
Ambient temperature: Room temperature

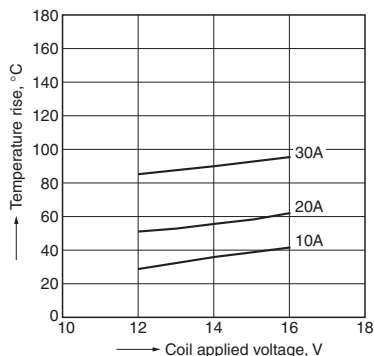

1.-(2) Coil temperature rise (at 110°C)

Sample: ACTG1H4, 3pcs.
Carrying current: 10A, 20A
Ambient temperature: 110°C

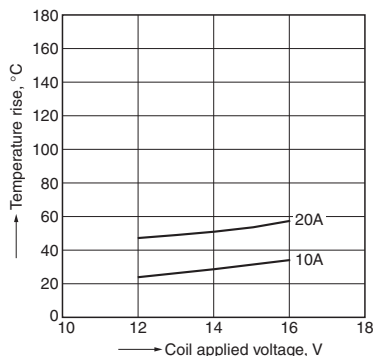

2. Ambient temperature and usable voltage range

Sample: ACTG1H4

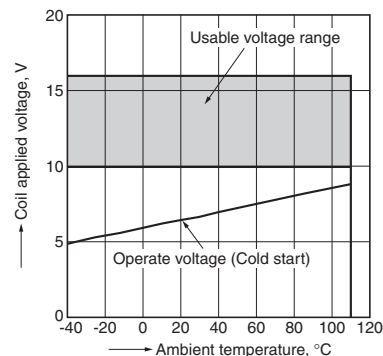

3. Distribution of operate (set) and release (reset) voltage

Sample: ACTG1H4, 40pcs.

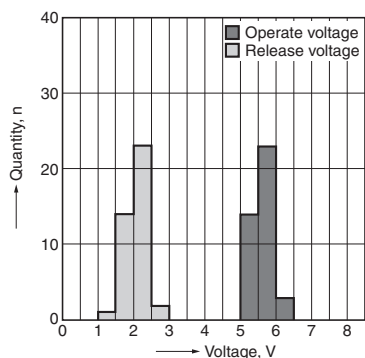

4. Distribution of operate (set) and release (reset) time

Sample: ACTG1H4, 40pcs.

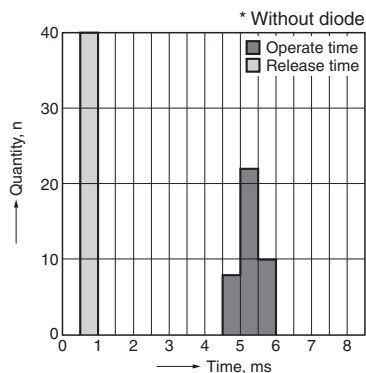

5.-(1) Electrical life test (Motor lock)

Sample: ACTG1H4, 6pcs.
Load: 30A 14V DC
Motor load (lock condition)
Operating frequency: ON 0.5s, OFF 9.5s
Ambient temperature: Room temperature
Circuit:

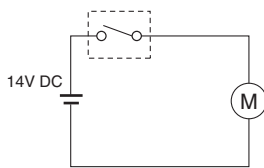

Change of operate (set) and release (reset) voltage

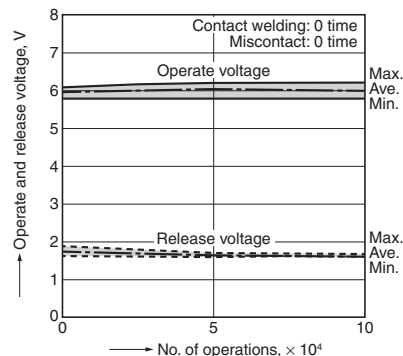

Change of contact resistance

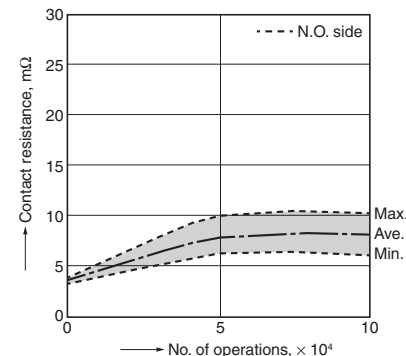

5.-(2) Electrical life test (Lamp load)

Sample: ACTG1H4, 6pcs.
Load: inrush: 84A, steady: 12A 14V DC
Operating frequency: ON 1s, OFF 14s
Ambient temperature: Room temperature
Circuit:

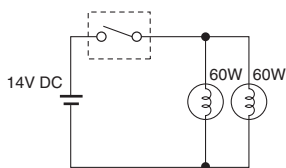

Change of operate (set) and release (reset) voltage

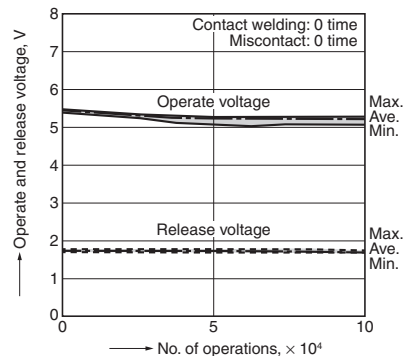

Change of contact resistance

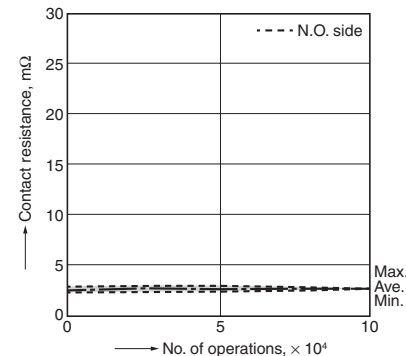

TG (ACTG)

DIMENSIONS (mm)

The CAD data of the products with a **CAD** mark can be downloaded from: <http://industrial.panasonic.com/ac/e/>

1 Form A type

CAD



External dimensions

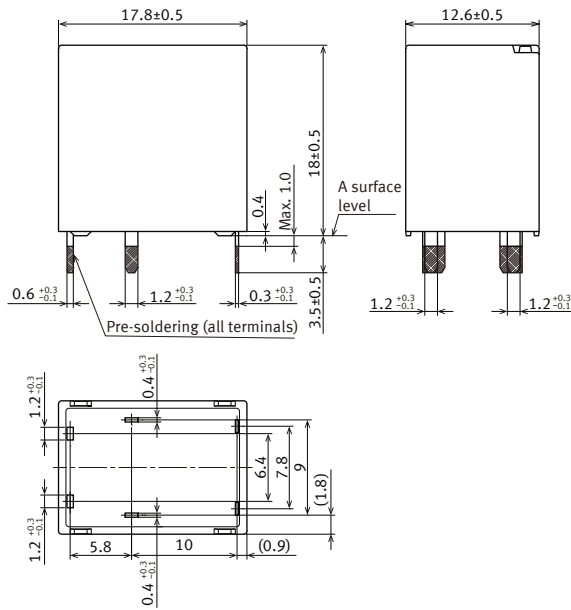

PC board pattern (Bottom view)

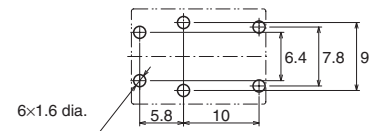

Tolerance: ±0.1

Schematic (Bottom view)

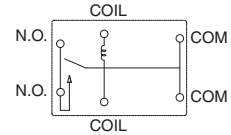

Tolerance
 Less than 1mm : ±0.1
 Min. 1mm less than 3mm : ±0.2
 Min. 3mm : ±0.3

* Dimensions (thickness and width) of terminal is measured after pre-soldering.
 Intervals between terminals is measured at A surface level.

1 Form C type

CAD



External dimensions

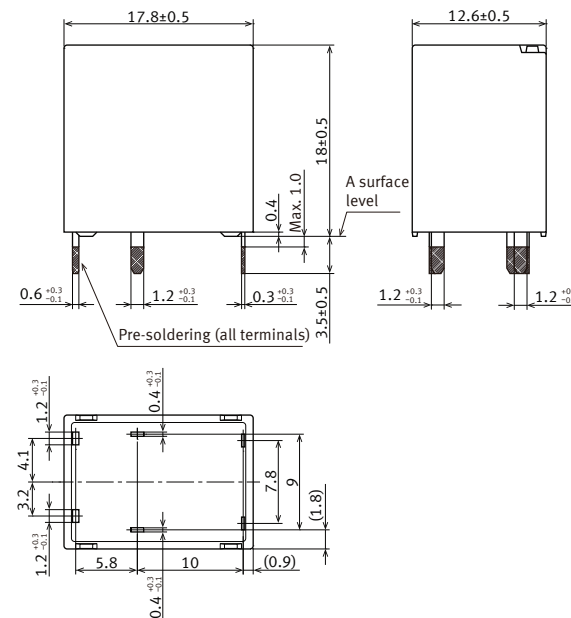

PC board pattern (Bottom view)

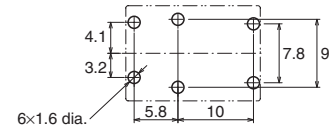

Tolerance: ±0.1

Schematic (Bottom view)

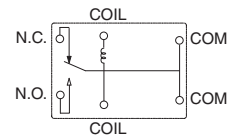

Tolerance
 Less than 1mm : ±0.1
 Min. 1mm less than 3mm : ±0.2
 Min. 3mm : ±0.3

* Dimensions (thickness and width) of terminal is measured after pre-soldering.
 Intervals between terminals is measured at A surface level.

NOTES

Usage, transport and storage conditions

1) Ambient temperature, humidity, and air pressure during usage, transport, and storage of the relay:

(1) Temperature: -40 to $+110^{\circ}\text{C}$ (High heat-resistant type)

(2) Humidity: 2 to 85% RH (Avoid icing and condensation.)

(3) Air pressure: 86 to 106 kPa

The humidity range varies with the temperature. Use within the range indicated in the graph below.

[Temperature and humidity range for usage, transport, and storage]

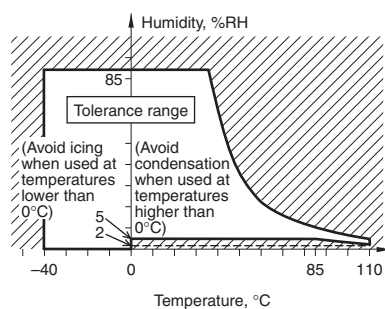

For general cautions for use, please refer to the “Automotive Relay Users Guide”.

Please contact

Panasonic Corporation

Electromechanical Control Business Division

■ 1006, Oaza Kadoma, Kadoma-shi, Osaka 571-8506, Japan
industrial.panasonic.com/ac/e/

Panasonic[®]

©Panasonic Corporation 2019